



Micro Commercial Components



Micro Commercial Components
 20736 Marilla Street Chatsworth
 CA 91311
 Phone: (818) 701-4933
 Fax: (818) 701-4939

MBRD10100

10 Amp Schottky Barrier Rectifier 100 Volts

Features

- Pb-Free Package
- Have Over Voltage protect loop, high reliability.
- Extremely Low Forward Drop.
- Epoxy meets UL 94 V-0 flammability rating
- Moisture Sensitivity Level 1

Maximum Ratings

- Operating Temperature:- 55°C to +150°C
- Storage Temperature: -55°C to +150°C
- Typical Thermal Resistance (Per Leg): 3°C/W Junction To Case

MCC Part Number	Device Marking	Maximum Recurrent Peak Reverse Voltage	Maximum RMS Voltage	Maximum DC Blocking Voltage
MBRD10100	MBRD10100	100V	70V	100V

Electrical Characteristics @ 25°C Unless Otherwise Specified

Average Forward Current	$I_{F(AV)}$	10A	$T_C=115^\circ\text{C}$
Peak Forward Surge Current	I_{FSM}	180A	8.3ms, half sine
Maximum Instantaneous Forward Voltage	V_F	0.66V(typ)	$I_F=10\text{A}; T_J=25^\circ\text{C}$
		0.73V	$I_F=10\text{A}; T_J=25^\circ\text{C}$
		0.63V	$I_F=10\text{A}; T_J=125^\circ\text{C}$
Maximum DC Reverse Current At Rated DC Blocking Voltage	I_R	50uA	$T_J=25^\circ\text{C}$
		15mA	$T_J=125^\circ\text{C}$

(TO-252) DPAK

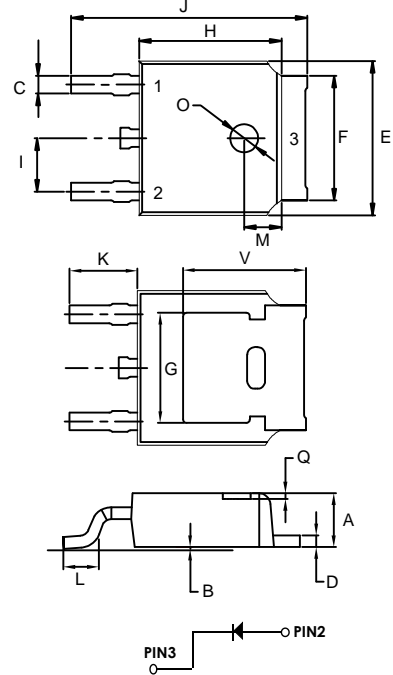

DIM	INCHES		MM		NOTE
	MIN	MAX	MIN	MAX	
A	0.087	0.094	2.20	2.40	
B	0.000	0.005	0.00	0.13	
C	0.026	0.034	0.66	0.86	
D	0.018	0.023	0.46	0.58	
E	0.256	0.264	6.50	6.70	
F	0.201	0.215	5.10	5.46	
G	0.190		4.83		
H	0.236	0.244	6.00	6.20	
I	0.086	0.094	2.18	2.39	
J	0.386	0.409	9.80	10.40	
K	0.114		2.90		
L	0.055	0.067	1.40	1.70	
M	0.063		1.60		
O	0.043	0.051	1.10	1.30	
Q	0.000	0.012	0.00	0.30	
V	0.211		5.35		

Figure 1: The forward voltage and forward current curve

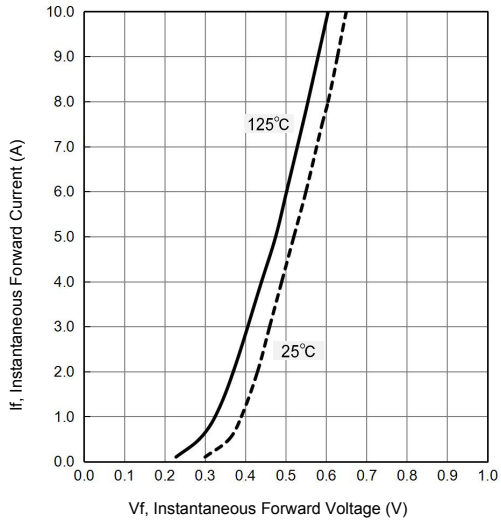
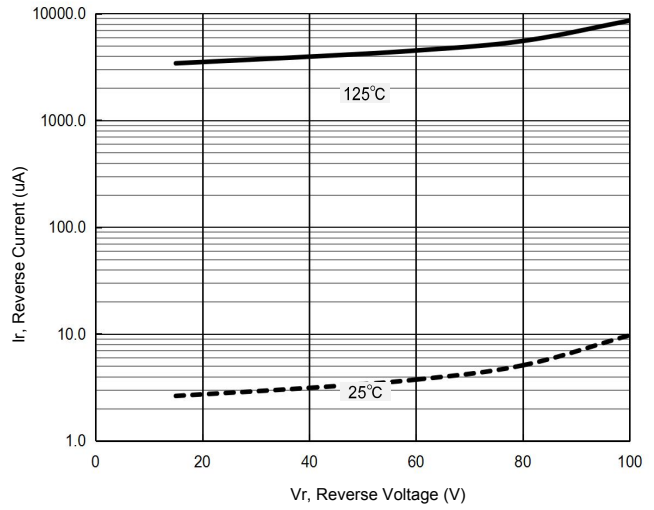

Figure 2: The reverse leak current and the reverse voltage (single-device) curve.





Micro Commercial Components

Ordering Information :

Device	Packing
Part Number-TP	Tape&Reel: 2.5Kpcs/Reel

Note : Adding "-HF" suffix for halogen free, eg. Part Number-TP-HF

IMPORTANT NOTICE

Micro Commercial Components Corp. reserves the right to make changes without further notice to any product herein to make corrections, modifications , enhancements , improvements , or other changes . Micro Commercial Components Corp . does not assume any liability arising out of the application or use of any product described herein; neither does it convey any license under its patent rights ,nor the rights of others . The user of products in such applications shall assume all risks of such use and will agree to hold Micro Commercial Components Corp . and all the companies whose products are represented on our website, harmless against all damages.

LIFE SUPPORT

MCC's products are not authorized for use as critical components in life support devices or systems without the express written approval of Micro Commercial Components Corporation.

CUSTOMER AWARENESS

Counterfeiting of semiconductor parts is a growing problem in the industry. Micro Commercial Components (MCC) is taking strong measures to protect ourselves and our customers from the proliferation of counterfeit parts. MCC strongly encourages customers to purchase MCC parts either directly from MCC or from Authorized MCC Distributors who are listed by country on our web page cited below. Products customers buy either from MCC directly or from Authorized MCC Distributors are genuine parts, have full traceability, meet MCC's quality standards for handling and storage. MCC will not provide any warranty coverage or other assistance for parts bought from Unauthorized Sources. MCC is committed to combat this global problem and encourage our customers to do their part in stopping this practice by buying direct or from authorized distributors.